

Data Sheet



Article number: 433000050

Description: Rota-fix shaft-hub connection C 50x57

Note: Not self centering. Small radial dimensions

Measures

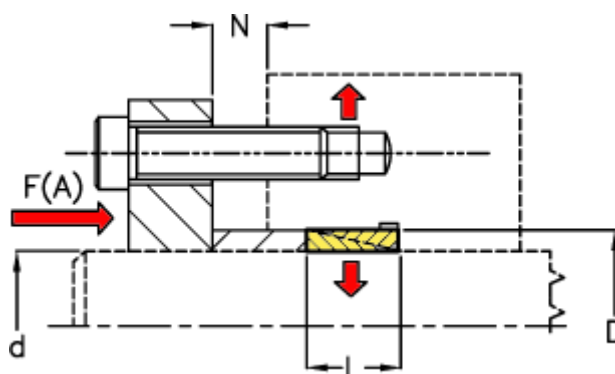

d mm = 50

D mm = 57

F(A) kN = 110

Fit tolerance = Aksel \varnothing ? 38 h6, Aksel \varnothing > 38 h8, Nav \varnothing ? 38 H7, Nav > \varnothing 38 H8

F kN torque = 19.0

L = 10

N1 = 4

N2 = 5

N3

N4

P N/mm² surface press

Surface roughness

T N m torque